

nanoFlash
Comprehensive FAQs
and Usage Guide
Including ASI

Firmware Version 1.5.126
10-Apr-10

Convergent Design, Inc
4465 Northpark Dr. Suite 400
Colorado Springs, Colorado 80907, USA
www.convergent-design.com

nanoFlash FAQs

Overview

1. Can I get a brief description and some photos of the nanoFlash?

nanoFlash is the world's smallest, lightest, lowest-power, professional HD/SD recorder/player. Easily mounted to your camera, nanoFlash is designed to record higher quality images than the camera itself, by capturing never-compressed video/audio from the HD-SDI or HDMI output.

nanoFlash un-throttles the very high-quality Sony MPEG2 CODEC, recording the video/audio onto affordable Compact Flash Media, at visually lossless rates up to 180Mbps (Long-GOP) or 280 Mbps (I-Frame). The footage can be stored in either Quicktime (MOV), MXF, or MPG file formats, providing universal NLE support as well as DVD / Blu-Ray authoring formats.



nanoFlash FAQs

2. What are the applications/benefits of nanoFlash?

- a. To upgrade the video/audio quality of your existing camera:
 1. 4:2:0 → 4:2:2 (color)
 2. 1440x1080 → 1920x1080 (full-raster)
 3. 25/35 Mbps → 50/100/140/180/280 Mbps (bit-rate)
 4. Compressed 16-bit audio → Uncompressed 24-bit audio
- b. Tapeless Workflow
- c. Enhance recording capabilities of your camera with pre-record buffer, pull-down removal, interval recording, redundant recording, etc.
- d. Presentations, Trade Shows, Theme Parks, Museums, Libraries, etc.
- e. Client / Feature Production Review
- f. Helicopters, Race Cars, Airplanes, Jets, and other high vibration applications
- g. Weather balloons, underwater footage
- h. Portable HD/SD recorder for switcher output
- i. POV camera recorder
- j. Video Assist
- k. Field Recorder
- l. Review Footage on any HDTV or HD-SDI or HDMI Monitor
- m. Real-time DVD / Blu-Ray Encoding (.mpg file)

3. Will nanoFlash work with my camera?

If your camera has an HD/SD-SDI or HDMI output with a compatible format, then the answer is yes. Some popular cameras include:

- a. Sony PMW-EX1, PMW-EX1R, PMW-EX3, PMW-EX350, F900, XDCAM HD, HVR-S270, HVR-Z5, HVR-Z7
- b. Canon XL-H1s, G1, HV20, HV30, HV40, HF10, HF11
- c. Iconix HD RH1
- d. Hitachi HV-HD30, DK-H32
- e. Ikegami HDL-2
- f. JVC GY-HD250, GY-HD251, GY-HM100, GY-M700
- g. Panasonic HPX170, HPX500, HDX900, HPX-300, GP-US932
- h. Toshiba IK-HD1, IK-HR1D, IK-HR1H, IK-HR1S
- i. Thomson Viper
- j. Vision Research Phantom Cameras (HD-SDI output)
- k. Wige Cumina Camera
- l. Easy Look Systems Cameras

4. Will nanoFlash improve the image quality of my existing camera?

Three major components largely determine the ultimate video quality from your camera: the lens, the CCD/CMOS sensor, and the built-in recorder. Some cameras do offer interchangeable lenses, so you may have the option to upgrade over the standard issue. The CCD/CMOS sensor is fixed on all cameras and cannot be modified. However, all HD-SDI and HDMI cameras allow users to upgrade the recording subsystem, which can yield significant improvement at reasonable costs. It's really quite simple, but let's first discuss the problem with your built-in recorder.

nanoFlash FAQs

Your camera's recording subsystem has two major components: the CODEC and the storage device. The CODEC compresses the video from about 1,200 Mbps (uncompressed HD) to a more manageable 18 to 280 Mbps. The storage device is typically a tape, optical disk, or possibly a memory card. Compressed video, along with audio and timecode, is stored on these media for playback or transfer to a NLE.

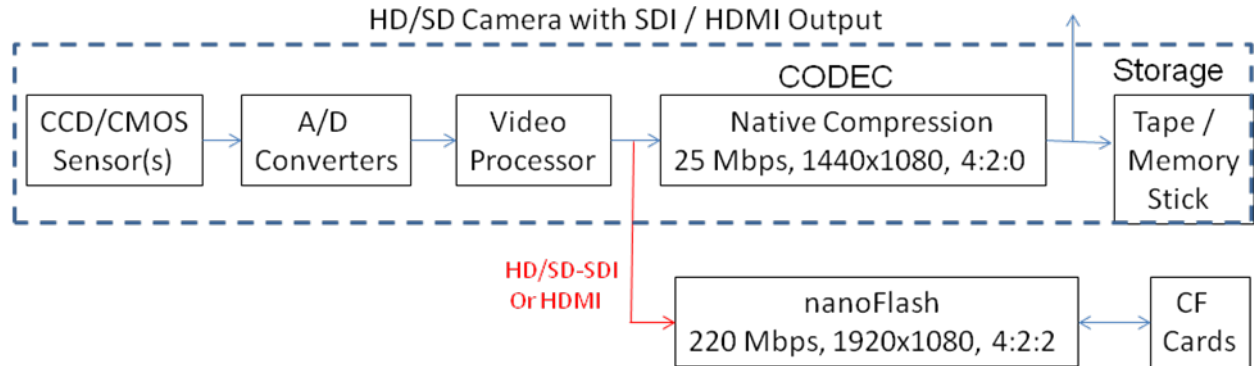

The CODEC and storage medium are both significant in determining your video quality. In general, the higher bit-rate produces better the video quality. However, most storage media severely restrict the possible data-rates. Mini-DV tape (used in HDV cameras), for example, has a fixed read/write bandwidth about 25 Mbps; SDHC memory cards are limited to about 45 Mbps. So, the ultimate data-rate from the CODEC must be restricted to match the performance of the storage medium.

The level of sophistication and implementation of the CODEC play a major role as well. I-Frame only CODECs, in general, require two to three times the bit-rate to equal the quality of the more sophisticated Long-GOP CODECs. (100 Mbps I-Frame is roughly equivalent to 35 Mbps Long-GOP in overall quality). Most CODECs, (HDV, DVCPRO HD, XDCAM EX, and even HDCAM) also reduce the potential quality through color-sample decimation (4:2:2 → 4:2:0 or 3:1:1) and/or by horizontally sub-sampling (1920 → 1440 or 1920 → 1280).

The Solution: nanoFlash – High Bit-Rate, Full-Raster, 4:2:2

The nanoFlash overcomes these quality-robbing restrictions in your camera. You connect to the HD/SD-SDI or HDMI camera output (in live mode) to send “never-compressed” video directly from the CCD/CMOS sensor to the high-quality CODEC and then to the high-speed digital storage (CompactFlash cards) in the nanoFlash.

Since nanoFlash records on CompactFlash solid-state memory, (as opposed to tape, optical disk or SDHC cards) the bit-rate can be substantially increased over your built-in recorder. For example, Transcend now offers a 64GB 400X Compact Flash cards which support data-rates up to 220 Mbps for approx \$200.

nanoFlash features a sophisticated high-quality Sony MPEG2 CODEC with data-rates up to 180 Mbps in Long-GOP mode (I,P,B Frames), and up to 280 Mbps in I-Frame-only mode. The CODEC compresses the video without reducing the color sampling (full 4:2:2) and without sub-sampling the horizontal data (full 1920).

nanoFlash FAQs

So what does full-raster (1920), full-color (4:2:2), high-bit rate (100+ Mbps), compression produce? Well, in independent tests, the results are clear: images that are visually indistinguishable from the uncompressed HD-SDI / HDMI images directly out of your camera! So, nanoFlash can vastly improve on the weakest link in the quality chain: your camera's built-in recorder.

Video/Audio I/O

5. **What video input and output connections are supported on nanoFlash?**
nanoFlash includes both HD/SD-SDI In and Out as well as HDMI In and out connections. The HD/SD-SDI connections are made via a standard BNC connector, while the HDMI I/O uses the new type C mini-HDMI connector (to save space).
6. **Which video input formats are supported?**
1080i59.94/50, 1080psf29.97/25/24/23.98, 720p59.94/50/29.97/25/23.98, 486i/576i
7. **What is the difference between HDMI and HD-SDI?**
HDMI is, in many respects, the consumer version of HD-SDI. Both HDMI and HD-SDI transport uncompressed high-definition video and audio. HD-SDI utilizes low-cost coax cable and is found throughout the professional video and broadcast industry. HDMI (High Definition Multimedia Interface) utilizes a more costly 19-conductor cable, but is the defacto interface standard for all HDTVs, consumer camcorders and now DSLRs. HD-SDI supports cable lengths to 150 meters, while HDMI is generally limited to 10 meters (without utilizing repeaters).
8. **Is there a quality difference between HD-SDI and HDMI?**
No, both HD-SDI and HDMI offer the same, high-quality, uncompressed signal from your camera. One is not superior to the other in terms of image quality. HDMI does not support timecode while HD-SDI does. The HD-SDI connector is also more durable and locking, as compared to HDMI.
9. **Will the nanoFlash record the HDMI output from my DSLR?**
Yes, the nanoFlash could be used to record the HDMI video out of your DSLR, providing that your DSLR outputs a standard HDMI signal. However, as of April 2010, none of the DSLR currently available has a live HDMI output of sufficient quality for recording with the nanoFlash. We do expect this situation to change in the not too distant future.
10. **Can I connect the HDMI output from the nanoFlash to my LCD/Plasma TV?**
Yes, virtually every HDTV display has one (or more) HDMI inputs, which are compatible with nanoFlash.
11. **Can the nanoFlash be connected to a DVI monitor?**
Yes. You need a simple HDMI to DVI adapter to connect to a DVI monitor. Note that DVI does not provide audio support, but you can connect the analog audio out of the nanoFlash to speakers or headphones, as desired.

nanoFlash FAQs

12. Can nanoFlash be upgraded to support 4:4:4?

No, this is outside the capabilities of the hardware design.

13. Will 1080p60/59.94 or 1080p50 be possible in a future release?

Support of these formats requires 3G HD-SDI (or dual-link 1.5GHz HD-SDI), which is not possible with the current hardware.

14. Can nanoFlash auto-detect the incoming HD/SD-SDI / HDMI stream?

Yes. Select the video input source: HDMI or HD/SD-SDI via menu control and nanoFlash will automatically sync to the incoming video. The format is displayed in the lower left corner of the LCD screen: 1080i50, 1080sf23, etc. (Note: No SRC = No Source detected).

15. Can nanoFlash be used as an HD/SD-SDI → HDMI or HDMI → HD/SD-SDI converter?

Yes, this capability is inherent in the design. Both outputs are live, even when the nanoFlash is not in record mode.

16. Does nanoFlash perform cross / down conversions?

No, nanoFlash does not perform 1080i ↔ 720p or HD ↔ SD type conversions. Our design goals limited the power and size of the box. Also, cross / down conversion was deemed unnecessary, as most video sources already provide this functionality.

17. Can nanoFlash remove the pull-down (inverse telecine) and record in 1080p24/23.98?

Yes, assuming the 1080i59.94 input was created using a 23.98p frame rate, and then the nanoFlash can remove the extra frames and record at the 23.98p frame rate. Both 2:3:2:3 and 2:3:3:2 cadences are supported with either HD-SDI or HDMI input.

This feature is enabled by selecting the 3:2 Removal in the menu. Note that the video format “1080pd23.9” will be displayed on the LCD screen.

18. Can nanoFlash also remove the extra frames on 720p24 over 60 formats (VariCam) and record 720p24?

Yes, additionally, the nanoFlash can remove the extra frames in 720p25 over 50 and 720p30 over 60 formats.

19. Can the nanoFlash perform a 3:2 pulldown and playback 1080p24 over 1080i60?

No, this capability is not planned for the nanoFlash, as most monitors support 24p.

20. Can I use two nanoFlash recorders for 3-D?

Yes, assuming both cameras are genlocked, then both nanoFlash units will be frame-locked together. We recommend using I-Frame only recording to ensure that each frame is compressed in an identical fashion. Note: for enhanced 3D recording and playback, please consider nano3D..

21. I understand that most cameras output 1080psf instead of true 1080p formats, what is the difference and how is this handled in the nanoFlash?

PSF (Progressive Segmented Frames) was developed for streaming 1080p HD-SDI

nanoFlash FAQs

through HD-SDI switchers. PSF formatting does not change your 1080p video whatsoever, but merely reformats the stream during HD-SDI transmission.

PSF breaks the progressive frame into two segments before HD-SDI transmission. The first segment contains the odd lines (1,3,5,etc.) of video and the second segment contains the even lines (2,4,6,etc). The two segments are automatically recombined appropriately before display and/or compression.

Almost all cameras transmit in 1080psf as opposed to 1080p format. Therefore it is critically important to set the PSF In and PSF Out checkboxes accordingly. If your camera is set for 1080p29.97/25/24/23.98 or 1080F mode (in the case of Canon), you will need to enable (check) the PSF In option to enable progressive mode processing. Because 1080i59.94 and 1080psf29.97 “look” identical on the HD-SDI bus, nanoFlash cannot automatically distinguish between the two formats.

If you do not enable “PSF In” your video will be processed as interlaced rather than progressive, with accompanying negative effects on the image quality. You can always verify that you have the correct setting by looking at the video format indicator on the lower left-hand corner of the LCD screen. You should see 1080sf29, 1080sf25 or 1080sf23 if the video source is one of the 1080p formats. Alternatively, if your video source is 1080i, then the PSF In should not be enabled (unchecked).

Normally, the incoming video is processed through a DDR memory where analog audio and time-code can be optionally added. However, if you enable E to E direct, then the incoming HD-SDI stream bypasses this processing and is merely routed from In to Out with zero delay. E to E Direct eliminates the frame delay of the DDR memory (which can prevent audio sync issues on the loop-out), but blocks the addition of non-embedded audio/time-code to the loop-out HD-SDI.

If the incoming source is 1080psf, then we recommend that you always choose E to E Direct, since the nanoFlash will output 1080p if E to E Direct is not enabled. Many monitors do not support true “p”, only “psf” video.

PSF Out should be enabled (checked) when connected to an HD-SDI based monitor. When connected to a DVI/HDMI monitor, PSF Out should not be enabled (unchecked).

Note that psf has no meaning whatsoever in 720p mode, so the selection of psf-in or psf-out will not affect the video in any manner. Also when recording 1080psf24/23.98 you do not technically need to select psf-in as nanoFlash will automatically detect this format (since 1080i48/47.96 is not a valid format). You should check psf-out during playback, as most monitors do not support true progressive HD-SDI.

22. Can nanoFlash support 2K formats?

No, unfortunately this is not possible.

23. Does nanoFlash have a genlock input?

nanoFlash FAQs

No; not in the traditional sense. When recording, you need to genlock the cameras. Since nanoFlash locks to the incoming HD/SD-SDI source, it will also be genlocked automatically. During playback, multiple nanoFlashes can be genlocked via a master HD-SDI distribution amp.

24. How can I monitor the video?

nanoFlash has both HD/SD-SDI and HDMI outputs which are simultaneously active during record (loop-thru) as well as playback.

25. How can I monitor the audio?

Audio levels are displayed on the LCD panel (2-Channels, -60 to 0 dB). nanoFlash also has analog audio out (via a 3.5 mm jack), which can be used with headphones or speakers (output limited to about 88 mW into a 16 ohm load). Also, this audio output can be configured for consumer line-level output (-10 dB).

26. Will nanoFlash support 4 or 8 channel audio?

Yes, nanoFlash support 2,4 or 8 channels of embedded audio.

27. What are the analog audio I/O choices?

Input: consumer line level (3.5mm jack) in either mono or stereo format, unbalanced consumer line level (-10 dB) or balanced microphone input (without bias voltage applied).
Output: consumer line level or headphone output (3.5 mm jack).

One should monitor the audio input levels and be prepared to reduce the consumer line-level input at the source if the level is too high.

28. Can the analog audio be recorded with the embedded (SDI) audio?

This capability, which would create a 4-channel recorder, is planned as part of the 8-channel audio firmware update, scheduled for mid 2010 release.

29. Can the audio be delayed / advanced relative to the video?

Not at this time.

Compact Flash Media / File Formats

30. Why Compact Flash?

Compact Flash (CF) is an industry standard memory card widely used in digital cameras. CF utilizes solid-state NAND Flash memory, and is extremely rugged (no moving parts), consumes very little power, is very reliable, low-cost and is available with a lifetime warranty from many manufacturers.

31. Why Compact Flash instead of SDHC?

SDHC cards, until very recently, were limited to about 50 Mbps and therefore unusable for high-quality, high bit-rate professional video. SDHC is a 4-bit bus, while Compact Flash uses a 16-bit bus for data transfers and therefore has higher potential bandwidth.

32. Why Compact Flash instead of a Hard-Disk Drive?

nanoFlash FAQs

- a. Solid-state media, no moving parts
- b. Low-power (about 1/10 of hard disk-drive)
- c. Very reliable (all solid-state); 100K write cycles, 10 year data retention
- d. Easily removable, 10K insertion cycles.
- e. Low-cost, about 1/3 to 1/10 the price of other professional solid-state media.
- f. High read/write bandwidth (up to 720 Mbps read/write speeds).
- g. Widely available (multiple vendors, many sales outlets)
- h. The price of CompactFlash cards is expected to come down, while the performance and capacity is expected to increase.
- i. CompactFlash memory is expected to increase in capacity, for example, 64 GB cards are now available

33. **Doesn't solid-state memory cost much more than hard-drives?**

Yes, in general solid-state memory is 3X (or more) times the equivalent cost of a mechanical hard-drives (on a GB basis). However, the reliability, power and size benefits far outweigh the cost in a portable recorder application.

34. **Can I write-protect the Compact Flash Card?**

Within the nanoFlash, you can write-protect the CF cards by selecting the "None" option on the record-trigger. This option also prevents CF card formatting. Unfortunately, CF cards cannot be write-protected in your PC/MAC.

35. **How many Compact Flash card slots on nanoFlash?**

nanoFlash supports two CF cards. Users can enjoy very long record times, as nanoFlash will automatically close one clip and start another on the next available CompactFlash card. This is seamless across both record and playback.

36. **Can I hot-swap the cards and continue recording indefinitely?**

This is planned for release in mid 2010.

37. **Can you record seamlessly from one CompactFlash card to another?**

Yes, as the remaining record capacity on the current CompactFlash card reaches a critical level, the nanoFlash automatically closes the current file, and then opens a new file on the next card. This process is completely transparent to the user, for both record and playback. No frames of video or audio are lost during this process.

38. **How do I know it's time to remove a Compact Flash card?**

There is bi-color LEDs next to each CompactFlash card slot, which indicates the current status of the card (idle, writing data to the card, ready to eject, etc). Also, the overall remaining capacity of each card is displayed on the LCD (0 to 100%), as well as the total number of minutes available across all cards.

39. **What are typical read / write speeds for Compact Flash cards?**

The read / write speeds of CF is based on the old Compact Disk standard of 1X = 150 KB/s. So, a 133X CF card is rated at 133 x 150 KB/s ≈ 20 MB/s or 160 Mb/s. Below are some example read / write performance measurements for CF cards tested and

nanoFlash FAQs

recommended for nanoFlash:

Manufacturer	Write Speed	Read Speed	Max Allowed Bit-Rate
PhotoFast 533X 64GB	380 Mbps	800 Mbps	220 Mbps
Delkin 420X 64GB	500 Mbps	500 Mbps	220 Mbps
SanDisk Extreme 32GB	480 Mbps	480 Mbps	280 Mbps
SanDisk Extreme Pro 64GB	720 Mbps	720 Mbps	280 Mbps

Note: Due to overhead considerations, such as opening and closing files and updating the directory and FAT32 table, the maximum allowable bit-rate must always fall below the theoretical write/read speed of a given Compact Flash card.

For a comprehensive review of Compact Flash cards and readers, please go to:

<http://www.hjreggel.net/cardspeed/index.html> or
http://www.robgalbraith.com/bins/multi_page.asp?cid=6007

40. How fast can I transfer the files to my local hard-drive?

Depending on the type of CF card and the speed of your hard-drive and PC/MAC, you can transfer 50/100 Mbps files at rates up to 8X/4X times faster than real-time. So one-hour of footage shot at 50 Mbps can be transferred in about 7.5 minutes; while the same footage shot at 100 Mbps requires about 15 minutes (since the file size is doubled).

The above assumes that a PhotoFast 533X CF card, a SanDisk Express 34 PCIe CF Reader and a fast (SATA-II) hard-drive. Transfer times will be much longer using a USB 2.0 card reader and moderately slower with a Firewire-800 reader.

You should also consider the use of the portable Nexto drive for backup and offloading of the CF cards. (See below for more details).

41. How fast to import clips into an NLE?

Almost instantaneously; since nanoFlash supports the native QT and MXF files used by most NLEs, you can play/edit the footage directly off the CF card without transcode or re-wrap of the data.

42. Which Compact Flash cards are qualified to use with the nanoFlash?



- SanDisk Extreme Pro: for all bit-rates
- SanDisk Extreme: for all bit-rates
- SanDisk Extreme IV: for bit-rates up to 220 Mbps
- SanDisk Extreme III: for bit-rates up to 180 Mbps
- Lexar 300X: for all bit-rates

nanoFlash FAQs

- Lexar 600X: for all bit-rates
- Delkin 305X: for bit-rates up to 220 Mbps
- Delkin 420X: for bit-rates up to 220 Mbps
- Transcend 400X: for bit-rates up to 220 Mbps

43. What happens if the selected bit-rate is too fast for a given CF card?

nanoFlash automatically stops, reduce the bit-rate to the next lower level, and re-starts recording. An error message: “Video Footage Lost, Card too Slow” is displayed.

44. What is the cost of the CompactFlash media?

The cost of CompactFlash media varies daily. Please check on-line retailers for latest prices.

45. Can you recommend a (water-tight) case for the Compact Flash cards?

Yes, go to <http://www.gepe.com/> for a comprehensive selection of Compact Flash cases.

46. What is the recording time?

The recording capacity depends on the bit-rate and the memory size of the card, as shown in the chart below:

Recording Time (Minutes)

Compact Flash Size	Long-GOP Rates						I-Frame Only Rates			
	5 Mbps	9 Mbps	18 Mbps	35 Mbps	50 Mbps	100 Mbps	140 Mbps	180 Mbps	220 Mbps	280 Mbps
One 16 GB Card	426	237	112	55	40	20	15	12	9	7
One 32 GB Card	852	474	224	110	80	40	30	24	19	15
64 GB (2-32GB Cards)	1704	948	448	220	160	80	60	48	38	30
128 GB (2-64GB Cards)	3408	1896	896	440	320	160	120	96	77	60

47. Do you use FAT32 file structure?

Yes, FAT32 allows the CompactFlash media to be easily used on both the Apple Macintosh and PC. With FAT32, the maximum file size for an individual file (clip) is limited to around 4 GB.

During record and playback, the nanoFlash seamlessly closes one file and starts another, even if the next file is on another CompactFlash card. A recording is not limited to the length of one clip. One can record continuously until all of the cards are full.

When editing, the individual clips can be easily put adjacent to each other on the timeline. For many editors, this can be quickly accomplished by selecting the desired group of clips, then dragging and dropping the group to the timeline.

The 4GB size of each clip is also desirable if one wishes to archive the clips on DVD's or other media that is limited in size. Additionally, the file size can be reduced using the “Max

nanoFlash FAQs

File Size” setting in the System Menu. Finally, you can “break” to a new file during a record session by pressing the record button for one second.

48. What is your recommended CompactFlash card reader?



USB 2.0



Firewire-800



Express Card 34

A USB 2.0 Compact Flash card reader is included with your nanoFlash, which is generally sufficient for 100 Mbps playback. The next performance improvement comes with a Firewire-800 reader, such as the one shown from Lexar. Finally, the ultimate performance choice is an Express Card 34 reader, such as the one shown from SanDisk.

Special note: Smooth playback at full frame rates may not be possible directly off the Compact Flash cards, especially at high bit-rates. We recommend that you copy the files to your hard-drive for optimum performance.

49. Is Compact Flash reliable enough for professional video?

Compact Flash has been widely adopted by professional photographers who demand the same reliability and data integrity as professional videographers. CF card manufacturers typically specify 100,000 write cycles and 10,000 card insertion / removals (well beyond typical expected usage). Some high end 300x cards are rated at over 1,000,000+ write cycles, which is higher than the rating for the typical 32 GB 133x card. In either case, there are more write cycles than one can expect to reach.

Each write cycle applies to individual memory cells, not to the device as a whole. Thus one can easily record well over 50,000 events. CompactFlash cards offer excellent shock and vibration characteristics. And many cards offer a limited lifetime warranty.

With an all solid-state construction, and mean-time-between-failure of greater than 1,000,000 hours, Compact Flash is arguably one of the most reliable mediums available to store your video.

50. What file formats are supported and how are they different?

nanoFlash currently supports three file formats: MOV (Quicktime), MXF, and MPG.

MOV is mainly for Apple Final Cut Pro and some others.

MXF is for AVID, Sony Vegas, Edius and others.

MPG is for creating files compatible with DVD and Blu-ray burning software.

nanoFlash FAQs

The video and audio data (the essence) is identical for MXF and Quicktime files. These file formats differ in the headers and the method the audio, video and time-code are multiplexed in the file.

MPG format allows one to record in SD at 5,6,7,8 or 9 Mbps and HD at 19, 25, 35 (4:2:0). If one records in MPG, one can use various utilities to create two “Elementary Streams”, one audio and one video. One such free utility is called “MPEG Streamclip”:
<http://www.squared5.com/>

Note:

If one provides HD to the nanoFlash via HD-SDI or HDMI, then the MPG files will be recorded in HD, which is appropriate for a Blu-ray disk. If one provides SD via SD-SDI or HDMI, then the MPG files will be recorded in SD, which is required if one wants to create a SD DVD.

51. **What is the recommended file format?**

MXF is supported on all PC based NLEs and is now compatible with FCP via the Sony import plugin (see section on NLEs). On the other hand, Quicktime is the default format for editing on the MAC and we offer a free QT → MXF converter. So, the ultimate file format choice depends on your specific application (and those of your clients).

52. **Can I record different video and/or file formats to the same Compact Flash card?**

File format changes are acceptable, but all the files must have the same video format (1080i60, 720p50, etc) for smooth playback out of the nanoFlash. However, if you do mix video formats on the same CF card, these files can be transferred to an NLE for editing.

53. **Can the CF cards be formatted on the nanoFlash?**

Yes. And for proper operation, you should format the cards in the nanoFlash. Both CompactFlash cards can be formatted simultaneously, which requires less than 5 seconds for two 32 GB cards.

Caution: be certain to remove all cards with footage before formatting any cards, as the formatting process clears all cards that are currently inserted in the nanoFlash.

54. **Can I copy files back onto a Compact Flash card for playback out of the nanoFlash?**

Yes, you need to first format the Compact Flash card on the nanoFlash and then copy the files into the clip folder.

55. **Can the Nexto device be used for temporary storage of the recorded clips?**

Yes, our testing has shown that the Nexto DI eXtreme ND2700 device is an excellent device for the temporary storage of your clips. The 500 GB Nexto is great for off-loading your footage onto another medium, especially when a laptop or other computer is not present. (http://www.nextodi.com/en/product/eXtreme_en.html)

nanoFlash FAQs



The clips on a CompactFlash card can be transferred to the Nexto's hard drive at approximately 25 megabytes per second (MBps). When extracting the clips to another computer, via the built-in ESATA interface, the transfer speed is approximately 60 MBps. We recommend purchasing the extra battery with the Nexto, as the internal rechargeable battery power is limited to a transfer of approximately 80 Gigabytes.

56. Can video data be transferred to XDCAM optical media for archival or delivery?

Yes, but you must record in the MXF file format at 50Mbps Long-GOP. The MXF files can be copied to the Sony XDCAM media for archival, delivery and playback in HD-1500 decks.



See: <http://blog.abelcine.com/2009/11/17/how-to-put-nanoflash-video-on-a-xdcam-disc/> for more details.

MPEG2 Compression

57. Why is video compression necessary?

Uncompressed HD video has a bit-rate of approximately 1200 Mbps or 125 to 150 MBps (Megabytes per second). This rate would quickly overwhelm the I/O capability (not to mention the storage capacity of most hard-drives). Compression reduces this data-rate by 10-fold, while allowing visually lossless re-creation of the original material.

58. Why was MPEG2 chosen?

MPEG2 is a very well proven, widely accepted format that offers many advantages in a portable HD/SD recorder/player, such as nanoFlash, including:

- a. Very wide range of supported bit-rates: 5 Mbps to 280 Mbps
- b. Sophisticated compression: I-Frame-Only as well as Long-GOP recording
- c. Master Quality Full-raster, 4:2:2 180 Mbps/Long-GOP or 280 Mbps/I-Frame-Only

nanoFlash FAQs

- d. Proxy recording at 18 Mbps 4:2:0 Long-GOP
- e. MPEG2 files can be played in DVD or Blu-Ray disks (use .MPG format)
- f. Universal native NLE support: FCP, Avid, Edius, Vegas, Premiere
- g. No need to transcode or translate files, plays directly off the CF card.
- h. Comprehensive HD and SD format support (1080i, 1080p, 720p, 480i, 576i)
- i. Low-power and small size hardware implementation (Sony CODEC module)
- j. Provides for a much faster, better editing experience than compared to some other CODECs.

59. What is the difference between I-Frame and Long-GOP?

I-Frame mode compresses each frame independently (spatial compression). Long-GOP consists of a compressed group of 12 to 15 frames starting with an I-Frame, followed by P (Predicted) and B (Bi-directional) frames. The P and B frames compress the difference of the current frame as compared to the original I-Frame (as known as temporal compression).

60. Will nanoFlash ever support uncompressed video record / playback?

Technically this is possible with the new SanDisk Extreme Pro Compact Flash cards. These new cards boast 90Mbps R/W speeds, so two cards in a Raid1 configuration would provide sufficient bandwidth for record/playback of uncompressed HD video. The video would not be stored in a single file-based format, however, and the record time would be limited to about 17 minutes (using two Sandisk Extreme Pro 64GB cards, which currently cost US \$700 each!). So while technically possible, we see very little gain in the video quality compared to the extra cost and headaches associated with uncompressed.

61. How is MPEG2 different from other CODECs?

MPEG2 can support highly efficient Long-GOP as well as Intraframe modes. With the nanoFlash you have the luxury of using either, as the situation warrants. Our MPEG2 is a very sophisticated high quality implementation. With some other CODECs, one may get 100 Mbps, but only in certain modes, with ours, if you choose 100 Mbps, you get 100 Mbps for 1080i60, and 1080p24 and all other modes.

62. Which NLEs support MPEG2?

Almost all professional NLEs support our XDCAM 422 MPEG2, including Avid, Final Cut Pro, Edius, Vegas and Premiere (with the Main Concept CODEC Plugin-see last page for special offer to nanoFlash customers..

nanoFlash FAQs

63. How does the video CODEC in nanoFlash compare with other industry standards?

Manufacturer	Panasonic	Sony	Panasonic	Apple	Sony	Convergent Design		Sony
Format	DVCPRO HD	HDCAM	AVC-I	ProRes	XDCAM 422	nanoFlash		HDCAM SR
Compression	DV	MPEG2-I	Intra	Intra	MPEG2-LG	MPEG2-I	MPEG2-LG	MPEG-4
Sampling	4:2:2	3:1:1	4:2:2	4:2:2	4:2:2	4:2:2	4:2:2	4:2:2 / 4:4:4
Resolution - 1080	1440 x 1080	1440 x 1080	1920 x 1080	1920 x 1080	1920 x 1080	1920 x 1080	1920x1080	1920 x 1080
Resolution - 720	960 x 720	1280 x 720	1280 x 720	1280 x 720	1280 x 720	1280 x 720	1280x720	1280 x 720
Quantization	8-Bit	8-Bit	10-Bit	10-bit	8-Bit	8-Bit	8-bit	10-Bit
Bit Rate (Mbps)	100	112 - 142	100	220	50	280	180	440

64. Does MPEG2, especially Long-GOP, suffer from motion artifacts?

Not at the higher bit-rates supported by nanoFlash. We see little or no motion artifacts at 50 Mbps and at 100 Mbps these artifacts are nearly impossible to find, even analyzing on a frame by frame basis at 400% zoom level.

MPEG2 can add I-Frame macroblocks into the P or B frames to compensate for parts of the image that were not present when the I-Frame was processed. So MPEG2 Long-GOP can adapt to very complex changing scenery, such as a water-fall or sparklers in which every frame is different from the next, or for situations like a ball dropping from the sky in the middle of the GOP.

65. Does nanoFlash support DV, DVCPROHD, DNxHD, Cineform or ProRes 422?

No, nanoFlash only supports MPEG2 compression (that's why the power dissipation, size, and weight are so low!)

66. Can I transcode to ProRes 422, DNxHD or another CODEC?

Yes, the transcode can either be performed in software or by placing nanoFlash in playback and capturing via an HD-SDI/HDMI input on your NLE.

67. Does nanoFlash actually record at higher quality levels than HDCAM?

Yes, HDCAM resizes 1080i/p video from 1920x1080 → 1440x1080 and then applies 3:1:1 color sampling. nanoFlash retains the full 1920x1080 raster and samples in 4:2:2. nanoFlash also has a higher compressed data-rate (less compression).

68. How does this compression compare to HDV?

HDV is also a form of MPEG2 compression, but it is always 4:2:0, and limited to 25 Mbps, and is 1440 x 1080. NLE's (Non-Linear Editors) have to go through a very compute-intensive task of converting each line of video from 1440 → 1920, while expanding the color from 4:2:0 → 4:2:2. This is a very compute intensive task, which creates long render times and less than full frame-rate playback. Our MPEG2 is always 4:2:2 full-raster, 1920 x 1080, so render and playback performance is greatly improved.

nanoFlash FAQs

69. How does this compression compare to the native Sony EX1/EX3 CODEC?

Compare the two images below, the left image is from the native XDCam EX is 4:2:0 at 35 Mbps, while the right image was recorded on the nanoFlash (via the HD-SDI out of the EX1) using the XDCAM 422 at 100 Mbps. Note this is an extreme pan and rotation test and not indicative of the normal quality from the EX1.

Parallel Recording: Sony EX1 and nanoFlash



35 Mbps 4:2:0 vs 100 Mbps 4:2:2

70. How does MPEG2 compare to DVCProHD?

DVCPro HD is an Intraframe only codec with a maximum bit-rate of 100 Mbps. DVCProHD resizes the video from 1920x1080 to 1440x1080 (50Hz) / 1280x1080 (60Hz) and then compresses the image. Our MPEG2 CODEC maintains the full-raster of 1920x1080 and produces superior image resolution.

nanoFlash FAQs

71. What recording options and formats are supported?

Quicktime (MOV) and MXF Bit-Rates

Bit Rate Mbps	CODEC	Audio Format	Color Sampling	Raster	Comments
100/140/180/220 /280	I-Frame	PCM 24-Bit 48K	4:2:2	1920 x 1080 / 1280 x 720p	
50/100/140/180	Long-GOP	PCM 24-Bit 48K	4:2:2	1920 x 1080 / 1280 x 720p	XDCAM 422
35	Long-GOP	PCM 24-Bit 48K	4:2:0	1920 x 1080 / 1280 x 720p	XDCAM EX
35	Long-GOP	PCM 24-Bit 48K	4:2:0	1440 x 1080 / 1280 x 720p	XDCAM HD
18	Long-GOP	PCM 24-Bit 48K	4:2:0	1920 x 1080 / 1280 x 720p	Proxy
30/40/50	I-Frame	PCM 24-Bit 48K	4:2:2	720 x 486i	SD - IMX
30/40/50	I-Frame	PCM 24-Bit 48K	4:2:2	720 x 576i	SD - IMX

MPG Bit-Rates

Bit Rate Mbps	CODEC	Audio Format	Color Sampling	Raster	Comments
35/25/19	Long-GOP	MPEG2-Layer 1 384 Kbps	4:2:0	1920 x 1080 / 1280 x 720p	Blu-Ray
5,6,7,8,9	Long-GOP	MPEG2-Layer 1 384 Kbps	4:2:0	720 x 486i	SD-DVD
5,6,7,8,9	Long-GOP	MPEG2-Layer 1 384 Kbps	4:2:0	720 x 576i	SD-DVD

72. Is the bit-rate constant with varying frame size and frame rate?

Yes, the bit-rate is independent of the frame size (1080 or 720) and the frame rate (24, 25, 30, etc). So the effective compression is actually lower at lower frame rates. With the nanoFlash, if you select 100 Mbps, you always get 100 Mbps, even if you are recording 24p. For example, 1080p24 at 180 Mbps is more than twice the bit-rate of DVCPHD or AVC-I, which scales the bit-rate to 80 Mbps when using this format.

73. Do you have a recommended bit-rate for most applications?

We believe that the 100 Mbps Long-GOP is the “sweet spot” for producing superb video quality at reasonable data-rates. Higher bit-rates will provide a very slight improvement in video quality, but at diminishing returns.

If one is recording images with an extreme amount of detail, lots of motion or explosions in the frame such as in an action movie; and lots of camera movement, such as when hand-held and running; then one may consider using 280 Mbps I-Frame. 100 Mbps Long-GOP would probably work great, but 280 I-Frame adds “insurance” against motion artifacts.

nanoFlash FAQs

74. Is the video of sufficient quality for output to film?

Yes, several films have already been released using the nanoFlash. However, we recommend using the 220 or 280 Mbps I-Frame for highest possible quality.

75. Is recording in 4:2:2 (as opposed to 4:2:0) really make a difference?

The resolution chart shows the clear difference between 4:2:0 and 4:2:2. Also notice the reduced artifacts (less noise around the text) at 100 Mbps.

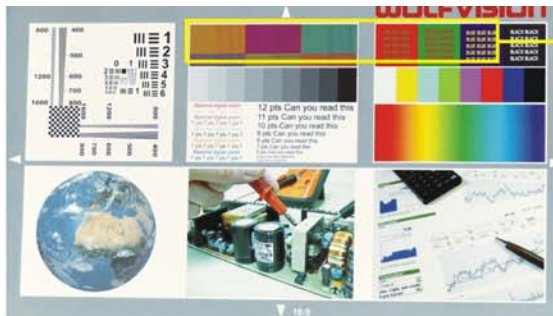

HD Codec and Color Space Comparison

Typical competitor 4:2:0 camera and codec

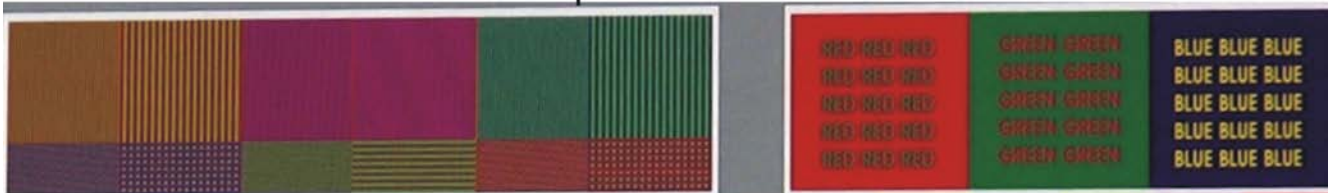

Sony PMW-EX3 4:2:0 at 35 Mps SxS

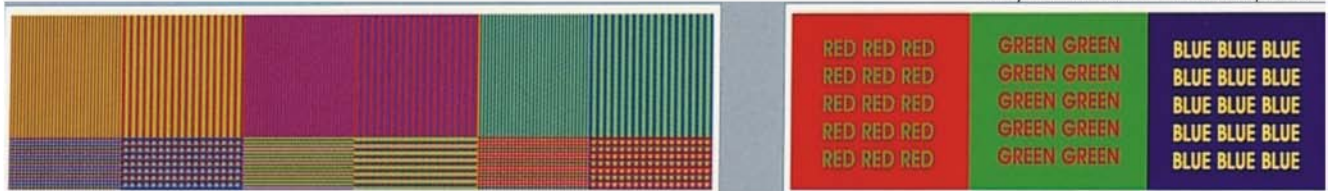

Sony PMW-EX3 4:2:2 at 100Mps nanoFlash

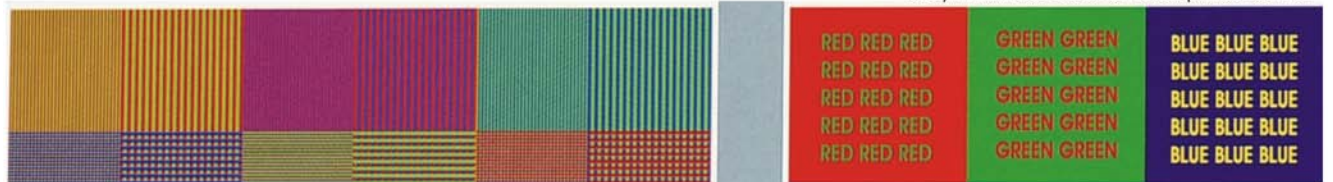

Note that above image only shows the quality difference using a static image. In general, the differences are magnified even further with high-motion footage.

Recording and Playback

76. Can I record to the internal tape / memory card on the camera (for backup) and to Compact Flash simultaneously?

Yes, you can also set the nanoFlash to trigger on incrementing time-code, so it will

nanoFlash FAQs

automatically start and stop recording when the record-button is pressed on the camera.
Note: your camera must be set to record-run time-code for this mode.

77. Can the nanoFlash be set up for time-lapse (interval) recording?

Yes, time-lapse is accomplished by recording the desired frames using I-Frame Only mode. The user can select the interval by selecting HH:MM:SS value in the menu. Since the effective data-rate to the CF card is reduced by 30X (or more), we recommend that all time-lapse recording be done at 280Mbps I-Frame Only mode, for maximum quality. Note that smooth playback out of the nanoFlash may be inhibited with slow CF cards. However, the video file can be transferred to an NLE for editing and playback. (Also note that Sony Vegas does not support I-Frame only recording and should not be used with Interval recording).

78. Does nanoFlash have a pre-record (Cache) buffer?

Yes, the pre-record buffer depends on the chosen bit-rate, as follows:

- a. 7 seconds for 100 Mbps (and lower) data-rate
- b. 4 seconds for 140/180 Mbps data-rate
- c. Pre-Record Cache is not available for 220 Mbps (or higher) recording

79. Can I loop record (overwriting the oldest footage)?

Yes, after recording to both CF cards the nanoFlash will automatically format the first card and continue recording. So, you will always have at least the last CF card's worth of video available when you stop recording.

80. Can I over/under crank (variable frame rate) during recording?

Yes, the nanoFlash records in I-Frame only with muted audio when operating in over/under crank mode. Please set your camera to output 720p60/50 or 1080p30. Then set the time base (24, 25 or 30) and the crank rate (1 to maximum incoming frame rate).

81. How do I know the nanoFlash is actually recording?

There are a number of record indicators, including:

- The LED next to the currently active CF card will flash red
- Record start/stop audio tones can be enabled in the HP output
- Red record overlay bar can be enabled on the output monitor
- The tally light will blink (option cable from the 10-pin remote)

82. What are the record trigger (start / stop) options?

Record start / stop can be triggered by one of 5 selectable events:

1. None (nanoFlash setup for playback only)
2. Incrementing time-code (Typically requires Record-Run timecode)
3. Record Start/Stop button on the nanoFlash box
4. External Remote Control switch
5. Auto Record on Power-Up

nanoFlash FAQs

83. How do I know the recording is active?

The nanoFlash displays red recording lights just above the Compact Flash slots and blinks the tally light on the optional remote control switch. Additionally, there are start and stop tones to the headphone which can be enabled.

84. Can I record the HDMI output from my Blu-ray Player?

No, the HDMI output from Blu-ray is encrypted via HDCP (High-Definition Content Protection) and cannot be copied.

85. Can I trigger multiple nanoFlash units to start recording simultaneously?

Yes, the simplest approach is to connect the remote start/stop triggers from all cameras together to one master start/stop switch. Also, the tally lights from all boxes can be wired together to a master tally light which is only active if all nanoFlashes are recording.

Finally, if all cameras are genlocked, then since the nanoFlash locks to the incoming HD/SD-SDI source, all nanoFlash's will automatically be genlocked together.

86. Can I trigger multiple nanoFlashes to start playback simultaneously?

Yes, the remote control input from multiple nanoFlashes can be tied together to a single master trigger switch. For frame accurate playback, a common HD-SDI reference must also be sent to all nanoFlash (through a distribution amp, for example).

87. Can I force the nanoFlash to switch to the next CF card during a record session?

This feature will allow users to remove a partially filled CF card, so the footage can quickly be moved to an NLE system. This capability is planned for release with hot-swap.

88. Does nanoFlash support fast-forward, rewind, or pause playback control?

Currently the nanoFlash supports normal play speed, pause and 2X/4X fast-forward. Tap the Play button to initiate/cancel Pause. Hold down the Play button to increase playback to 2X or 4X.

89. Can I jump from clip to clip (or file to file) during playback?

Yes, you can jump from clip to clip using the up and down arrows and jump from file to file using the right and left arrow buttons during playback..

90. Can I loop on a particular clip during playback?

Currently you can loop on all video files only. A future release will add the option to loop on a particular clip.

91. What parameters are displayed on the LCD screen during recording?

- a. Total remaining recording capacity (in minutes), total of all CF cards.
- b. CF card level meters (0 to 100%)
- c. Current Time-Code (HH:MM:SS;FF)
- d. Current Video Input Format (1080i59.94, etc.)
- e. Audio Level Meter (2-Channels: -60 to 0 dB)
- f. File Name and Recording Format (QT, MXF, or MPG)
- g. Incoming power voltage level (useful for battery monitoring)

nanoFlash FAQs

92. What is the file naming convention used in nanoFlash?

File Names are 8 character name + 3 character extension (.MOV/.MXF/.MPG)

File name = XXYYYYZZ

XX = Camera ID or Unit ID, Set by the user

YYY = Clip Number (which increments with each record session)

ZZZ = File Number (which increments automatically across 4GB boundaries)

The Clip Number is remembered, even if the nanoFlash is powered down.

The File Number always starts with 001 for each new clip.

Note: Our file naming convention is very appropriate as files loaded into a folder will automatically sort into a useful order: By camera, then in ascending order. This makes “dragging and dropping” a group of files to the timeline very easy.

93. How will the nanoFlash respond if I lose the HD/SD-SDI or HDMI source during record?

The nanoFlash will simply close the current clip, wait for the video input to become valid and then restart recording by opening a new clip.

94. What happens if I lose power during a record session?

Currently, the last file (a sub-clip) will be corrupted and thus will be lost. During a long recording session, the overall recording is broken down into files (sub-clips), each under 4 Gigabytes each. Only the last sub-clip will be corrupted. You can also reduce the Max File Size to further minimize losses.

95. Can I lock out the keypad during recording (backpack usage)?

Yes, if you select the remote control trigger, the keypad is locked-out during a record session. You can also disconnect the remote cable during a record, if desired.

96. Does nanoFlash have a record review option?

A record review function, which will play back the last 10 seconds of video after a record session is complete, is planned in a future firmware update.

97. Can I delete the last clip?

Yes, please see owner’s manual for details.

98. Can you explain the usage in Digital Signage / Presentations?

nanoFlash offers two distinct operating modes for digital signage / presentations

Single-Channel, Multi-Display using HDMI to Consumer Display

Single-Channel, Multi-Display using HD/SD-SDI to Professional Display

Single-Channel, Multi-Display Using HDMI

nanoFlash can be directly connected to virtually any consumer HD display via HDMI.

Multiple displays can be driven using a HDMI distribution amp. This topology can be very cost-effective assuming short cable runs.

nanoFlash FAQs

Single-Channel, Multi-Display Using HD/SD-SDI

nanoFlash also features an HD/SD-SDI output, which can be connected to an SDI distribution amp to simultaneously drive multiple professional monitors. Cables runs up to 150 meters (per link) are possible using HD-SDI connections.

99. How can nanoFlash be used in video assist applications?

Currently, users can play back any file using the control panel. You can also move from file to file very quickly using the right and left arrows.

We are now developing remote RS-485 control, which will allow the playback of any selected clip from one or more nanoFlash units, via a simple menu selection on the remote PC/handheld. Metadata can also be input via this simple connection.

100. Does nanoFlash have an internal clock?

nanoFlash has an internal high-precision real-time clock with battery backup (10-year projected life).

101. Can the internal clock be synchronized to GPS (UTC) time?

A comprehensive, extra cost, feature will be offered in summer 2010, which will allow this functionality. Our GPS feature will also provide GPS information to be added to each second of video.

102. Does nanoFlash have an LTC time-code input?

Yes. Multiple units can be synced to a master time-code generator or other timecode source. Also, using a low cost BNC "T" (or "Tee") connector, one timecode source can be easily feed to multiple nanoFlash units. The nanoFlash is specifically designed for this purpose.

The nanoFlash's timecode input is via the Hirose 10-Pin Remote Control connector. We offer special cables with Female BNC connectors to provide access to the timecode input.

103. Can nanoFlash act as a time-code generator?

No, nanoFlash can receive timecode from an LTC source or HD/SD-SDI embedded. NanoFlash, and also has an internal time-code generator, but cannot source (output) timecode.

104. Can I jam-sync the time code?

Yes, but the initial implementation requires that the HD-SDI source be continuously active (hot) to maintain the time-code.

105. What are the time-code input options?

- a. Embedded in HD/SD-SDI stream per RP-188
- b. LTC-In (Linear Time Code)
- c. LTC-In Jam Sync
- d. Internal Record-Run (with preset option)
- e. Time-of-Day

nanoFlash FAQs

NLE Support and Workflow, DVD/Blu-Ray Encoding

106. Can I convert my existing camera to tapeless workflow?

Yes, while your camera may be designed for tape-based recording, the nanoFlash converts it instantly to a tapeless workflow with all the benefits therein.

For example, with tape, many film producers and crew are very reluctant to rewind a tape to review the recorded clips. This is for many reasons, foremost is the more a tape is handled (rewound, played, fast forwarded), the more likely a dropout is to occur. Secondly, repositioning the tape after playback must be done precisely. If done incorrectly, existing footage could be overwritten.

But with the tapeless workflow, in the nanoFlash, the last clip may be played back instantly at the press of one button. Then, even while playing back a clip, the unit is ready to record instantly, and no existing footage will be overwritten.

Even more important, is the elimination of the capture process. Capturing takes place in real time, with the camera or tape deck playing the footage, while the computer “captures” the digital data.

With a tapeless workflow, the nanoFlash creates individual clips for each take or recording. These individual clips can be copied in bulk, faster than real-time, to your computer system. In addition, if desired, you can choose to only transfer the good takes, without spending any time repositioning the tape.

If you have a fast CompactFlash card reader, such as the Lexar Firewire 800 unit, then you can actually play or edit the clips directly from the CompactFlash Card. Also, these readers can be daisy-chained together, so you can start a process to transfer up to four CompactFlash cards without further attention.

However, unless one is really pressed for time, we recommend copying the clips to your computer’s hard drive first, prior to editing.

Tapeless Workflow Advantages

- No tape deck required (use low-cost Compact Flash card reader)
- No tape-deck maintenance costs
- Better Video Quality (above HDCAM)
- No Digitizing, direct file transfer
- Pre-Record Cache (7 seconds at 100 Mbps)
- Time-Lapse Capability
- Redundant Recording Capability
- Loop Record Capability
- Metadata
- Option to add GPS data
- Ability to adjust the bit-rate (18 to 280 Mbps) to match the specific requirements

nanoFlash FAQs

- No humidity issues
- No tape dropouts
- Hot-swap for endless record time
- Much longer record times 5.3 Hours at 50 Mbps for one load of two 64 GB cards
- Much less weight, power, size, no fans
- Simple Playback on any “take”, can immediately switch back to record.
- Much less storage volume and weight compared to tape.
- Much less shipping costs and power requirements compared to tape decks.
- Much less initial cost and maintenance cost.

107. **Can I instantaneously import the video to my NLE for editing?**

Yes. Using a USB 2.0 or FireWire-800 reader you can import the video files directly to your NLE. See Compact Flash section for more details.

108. **Do the nanoFlash clips work natively in FCP, Avid, Edius, Vegas or Premiere?**

nanoFlash has excellent NLE support, with a few caveats:

Final Cut Pro (6.0.4 or better)

FCP supports playback of all nanoFlash files recorded as Quicktime (.MOV) files. A timeline may be created for the nanoFlash files (50 Mbps and greater) in Final Cut Pro under the Easy Setup “XDCAM HD 422”. Rendering / re-encoding (to 50 Mbps only) is also supported.

Special note: although the XDCAM 422 in FCP is labeled as a 50 Mbps CODEC, it will easily support much higher bit-rates during playback. You can use the “Movie Inspector” in the Quicktime player to verify that indeed the bit rate from nanoFlash is 100 Mbps (or higher).

Avid Media Composer (4.0.5 or better)

- I-Frame only formats are supported (MXF files).
- Long-GOP formats up to 50 Mbps are supported; higher Long-GOP rate support is expected in the near future
- Standard Def is supported.
- Avid AMA support is also expected in the near term

Sony Vegas (9.0c): all MXF files; Long-GOP Only

Edius 5: all MXF files; Long-GOP and I-Frame

Matrox Axio: all MXF; Long-GOP and I-Frame

Adobe Premiere CS3/CS4/CS5

Full CODEC support in Adobe CS3/4 requires the Main Concept Plugin for CS3/4 (See *the last page of the FAQs for a special offer for nanoFlash customers*). CS5 has native support for all nanoFlash CODECs.

nanoFlash FAQs

109. Can I playback the clips on my PC or MAC?

Yes, there are a number of available viewer programs, including:

- Playback of MXF Files on PC (no NLE required)
[PDZ-VX10 Full Resolution Viewer Version 2.30](#) (XDCAM Viewer Software)
- Playback and Import of MXF (to QT) Files on Mac (with FCP)
[PDZ-KP1 XDCAM Transfer Software Version 2.10.0](#)
- Playback of MXF files on MAC (without FCP)
Use [PDZ-KP1 XDCAM Transfer Software Version 2.10.0](#) and this CODEC:
[Calibrated {Q} XD Decode](#)
- Playback of QT files on MAC (with FCP)
FCP Version 6.03 (or later) has native support for all QT files
- Playback of QT files on MAC (without FCP, uses Quicktime Player)
Requires [Calibrated{Q} XD Decode](#) (choose MAC version)
- Playback of QT files on PC (uses Quicktime Player)
Requires [Calibrated{Q} XD Decode](#) (choose PC version)
- Other 3rd Party Plugins to Consider
Open Cube <http://www.opencubetech.com/>
MXF4MAC <http://mxf4mac.com/>

110. Can I convert from QuickTime → MXF file format?

Yes, Convergent Design has written a QT → MXF converter, which operates only on the MAC. You can download the free converter at: <http://www.convergent-design.com/downloads/FileConverter.zip> A PC version of this converter is planned for a future release.

111. Can I convert from MXF → Quicktime file format?

Yes, the [PDZ-KP1 XDCAM Transfer Software Version 2.10.0](#) transfer software will convert from MXF to Quicktime, but only on the MAC. You must have either FCP installed or purchase the [Calibrated{Q} Decode](#) module (MAC version)

112. Can I play back footage (out of the nanoFlash) that was created in my NLE?

Yes, but playback is limited to 50Mbps 4:2:2, here's a guideline of the steps:

Format a qualified CF card on the Flash XDR / nanoFlash
Insert card to USB / Firewire Reader attached to Mac

For originally recorded files: on a Mac copy the files using this utility's non-fragmented copy to the CF card (the }CLP{ folder). These can be Quicktime, MXF, MPG, or M2V files in their originally recorded form. (On a PC, files can be copied from Explorer, as

nanoFlash FAQs

Explorer doesn't appear to fragment files on the card.)

For files exported from Final Cut Pro or other Quicktime compatible software (.MOV in the XDCAM EX or XDCAM 422 profile only, files must be less than 32 Gbytes each) : use this utility's conversion tool to make a Flash XDR / nanoFlash compatible copy of the files, selecting the CF card volume as the destination folder.

Place the CF card back into the recorder, and press the play button. Do not press the record button in this case; record will overwrite any copied files on the card. Alternatively, set the System->Record Trigger to None, which will prevent accidental records. Use the right / left arrow keys to skip between files.

** Note that all files played out of the XDR / nanoFlash on a CF card(s) must be the same video format / file format.

113. I don't see the 100 Mbps XDCAM 422 or the 180 Mbps I-Frame CODEC in my NLE, are they really supported?

Yes, use the Movie Inspector (in the Quicktime Player). If one compares the size of the files to typical 50 Mbps files, one can see that the extra data is actually present.

114. Can I concatenate multiple 3.5 MByte files from nanoFlash into one large file?

You can concatenate mpg files using the "cat" function on the MAC. But MXF and Quicktime files can not be simply butted together to form a new larger file.

115. Can I see some sample footage?

Please see our website for sample footage and image comparisons:

www.convergent-design.com.

116. Can I record video directly out of my NLE?

Yes, just connect the HD-SDI or HDMI out of your NLE directly into the nanoFlash and activate record.

117. Can nanoFlash encode video in real-time for DVD or Blu-Ray authoring?

Yes, this is supported via the MPG (audio and video) file format.

118. How long does it take to create a DVD?

Using Nero 9 with a fast Compact Flash card, an Express 34 Card reader and a fast hard-drive system, it takes 25 minutes to transfer 1.5 hours of MPG footage (recorded at 5 Mbps) to a DVD, ready for playback in a DVD player (time measured from insertion of CF card into PC till DVD pops out).

119. What about metadata?

The nanoFlash will support metadata in a future release. The complete list is still under development, but information such as time-of-day, location, shoot number, event, DP, etc are planned.

nanoFlash FAQs

User Interface / Remote Control

120. How is the nanoFlash configured?

Currently, the nanoFlash is configured using the front panel control. Settings are saved and are automatically restored during power-up. In a future release, we plan on supporting setup profiles.

121. What is the configuration for the remote control?

The remote control connector is a lockable 10-pin Hirose connector. The corresponding plug is available from www.Digikey.com. Hirose part # HR1673-ND, crimp Version (requires special tools); Hirose Part # HR1635-ND is the solder version.

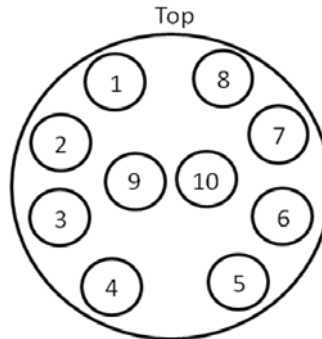

10-Pin Remote Connector
Viewed from Back of nanoFlash

Pin 1 = LTC In

Pin 2 = RS485+/RS232RX

Pin 3 = RS485-/RS232TX

Pin 4 = Start/Stop Record (simple closure to ground will activate start/stop record)

Pin 5 = Tally LED Output (10ma @ 3.3V, sufficient for most red LEDs)

Pin 6 = +5.0V @ 80 mA max

Pin 7 = Ground

Pin 8 = Ground

Pin 9, 10 = No Connect

122. If I am using the Remote Control, how can I be certain that I am recording?

The tally light will blink if you are recording. If it stops blinking, either "On" or "Off", you are not recording.

123. Can nanoFlash be connected to a GPS receiver?

This is planned for a 2010 release as an extra cost feature.

124. Any plans for wireless control?

Under consideration for 2010.

125. Can nanoFlash be controlled externally via an RS-485 bus?

The nanoFlash has built-in RS-485 hardware. Convergent Design is developing a USB to RS-485 dongle which will allow users to control one or more nanoFlashes, connected on a common bus, via a laptop or other handheld device (with USB connectivity).

nanoFlash FAQs

This is planned as extra cost feature, and is expected to be sold as a package with software that controls the nanoFlash from a Mac or a PC.

Mechanical / Power / Environmental

126. What is the size and weight of nanoFlash?

The nanoFlash is camera mountable: 107 (L) x 94 (W) x 36 (H) mm (4.2 x 3.7 x 1.4”), and the weight is approximately 0.4 kg (15 oz).

127. Can I mount nanoFlash to the back of my camcorder?

We offer a Hotshoe Ball Mount that works very well with many cameras.

We also have an IDX mount which allows the nanoFlash to attach, as if it was an IDX battery. This allows for a physical mounting, but does not supply power. This works especially well with the IDX “Piggyback” type battery. We offer a similar mechanical mounting for Anton Bauer gold mounts.

We offer a custom mount for the Canon XL H1 and XL H1s.

For those with 15mm rails off the back of the camera, we offer a 15 mm rail mount, which can also be used with an Anton Bauer Gold Mount Adapter Plate. This allows the popular Anton Bauer Gold Mount batteries to be used.

128. Can I mount the nanoFlash in the cold/hot shoe on my camcorder?

Yes, a cold/hot shoe mount is available which can be screwed into the tripod mount on the bottom of the nanoFlash case, see:

<http://www.manfrotto.com/Jahia/site/manfrotto/pid/86>



Tripod to Hot-Shoe Mount

129. When does the nanoFlash go from Active to Standby Power?

nanoFlash FAQs

nanoFlash can detect the presence of a valid HD/SD-SDI input. Therefore, it can be programmed to switch from active state (6 Watts power) to standby state (0.2 Watts of power) when the HD/SD-SDI signal is turned off (when you turn off your camera).

nanoFlash requires about 4 seconds to reboot when the HD/SD-SDI signal re-appears. nanoFlash automatically powers down the SDI transmitter and the HDMI I/O if no cable connection is detected. When the HDMI input is active, due to technical limitations, the nanoFlash cannot detect when the HDMI signal goes away, thus the nanoFlash cannot enter low power mode automatically.

130. What type of battery can be used with the optional battery adapter?

We also offer our own battery and charger for the nanoFlash. It offers a run time of approximately 3.0 hours.

131. Can nanoFlash monitor the battery level?

nanoFlash does not have a battery gas gauge per se, but does display the incoming voltage. So, by watching the voltage level, you can easily determine if the battery is nearly discharged. In a future firmware update, the nanoFlash will automatically close the last clip and power-down when the battery is near full discharge level.

132. What are the power cable options offered by Convergent Design?

We offer three power cable options:

- a) 4-Pin Hirose to D-Tap
- b) 4-Pin Hirose to XLR
- c) 4-Pin Hirose to Flying Leads (for DIY users)



4-Pin Hirose to 2-Pin D-Tap



Remote Start & Tally



HD-SDI Cable

133. Does nanoFlash have an internal fan?

No, nanoFlash utilizes substantial internal heat sinks to dissipate the heat to the aluminum case. Fans were deemed too noisy and a reliability issue.

134. What material is used for the cabinet?

The cabinet is all aluminum, since it is rugged, lightweight and has excellent heat conduction characteristics.

135. Does nanoFlash include a battery or any power supply?

nanoFlash has a 4-pin Hirose power jack for battery power, or for DC power from the 110/220V AC power supply included with the nanoFlash. The nanoFlash does not

nanoFlash FAQs

include an internal battery, but our battery will be available with a case that attaches to the side of the nanoFlash.

136. What is the power input requirement and the connector specification?

The nanoFlash consumes about 6.0 watts active / 0.2 watts standby.

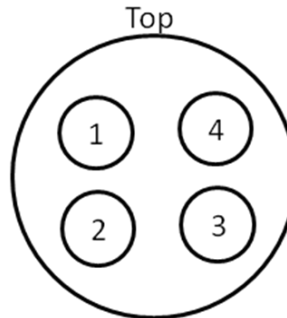

Power Connector
Viewed from Back of nanoFlash

Pin 1 = Power
Pin 2 = Power
Pin 3 = Ground
Pin 4 = Ground

The corresponding **power plug connector is a Hirose HR10A-7P-4S(73)** (Solder Version) or **HR10A-7P-4S(73)** (Crimp Version), available from www.digikey.com.

The input voltage range is +6.5V to +19.5V DC. The nanoFlash does have an internal resettable fuse and overvoltage / reverse voltage protection.

137. Does the nanoFlash have internal temperature monitoring?

Yes, the nanoFlash has an internal temperature monitoring, which is displayed on the system menu. The internal video processor chip will automatically shut down at approximately 100 degrees C, which is far beyond normal operating range (even in the desert).

138. Can I power / mount nanoFlash to an Anton Bauer / IDX battery?

You can power the nanoFlash via a D-Tap to 4-pin Hirose cable, available from Convergent Design. We have various mounting plates for these batteries.

139. Can nanoFlash operate off the 7.2V / 14.4V Lithium Ion battery on my camcorder?

Yes, provided your camera has a power outlet, but you will likely need to increase your battery size to accommodate both your camera and the nanoFlash. The nanoFlash draws about 1.0/0.5 amp from a 7.2/14.4V battery in active state and 0.030/0.015 amps in standby state.

140. Can nanoFlash be used in high vibration applications (race cars, airplanes, helicopters, etc)?

nanoFlash FAQs

Yes, the nanoFlash is already field proven in these applications - it's 100% solid-state, no moving parts.

141. What is the operational temperature range?

-40 to 70 degrees C (-40 to 158 degrees F)

142. What is the altitude range of the nanoFlash?

The nanoFlash has been field-proven to altitudes of 30,000 meters (98,000 feet).

143. What humidity levels are acceptable?

nanoFlash has a wide humidity range of 5% to 95%, non-condensing.

nanoFlash FAQs

144. Can I get a drawing of the bottom mounting plate?

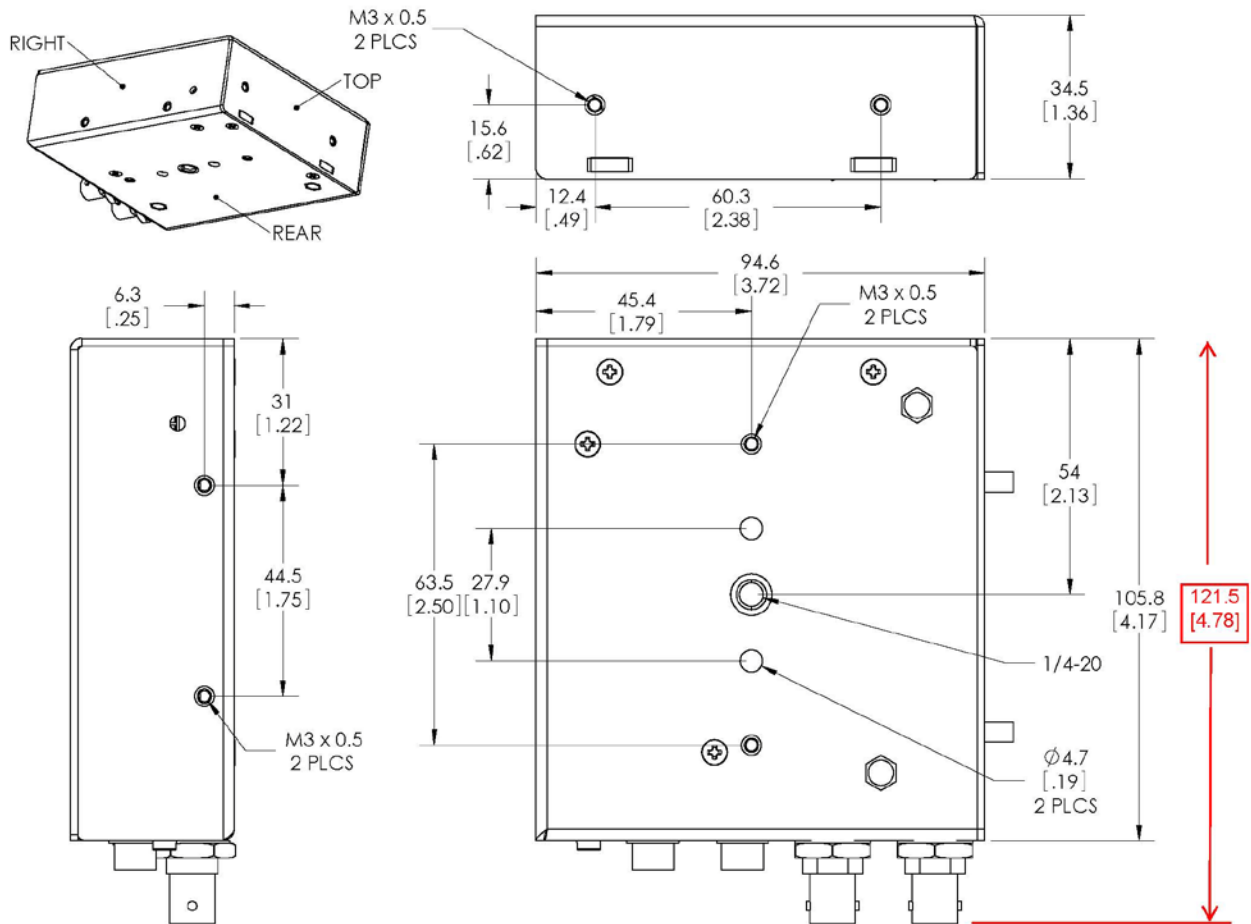

General Questions

145. How can I connect the nanoFlash to my Sony EX1/EX3 camera?

Power options: SWIT battery or Coco adapter.
Most popular mounting option: NebTek adapter.

146. How can I connect nanoFlash to the Canon XL H1 or XL-H1s?

The original Canon XL-H1 did not have embedded audio or time-code. However, you can connect the analog audio outputs to the nanoFlash via a common RCA to 3.5mm cable.

Time-Code can also be transferred via the LTC input on the nanoFlash. One of our cables, with timecode option will be necessary.

147. Can I really get 1080i recording from the JVC GY-HD250 camcorder?

Yes, the GY-HD250 can be switched to output either 720p or 1080i HD-SDI. Internally,

nanoFlash FAQs

only 720p HDV data can be recorded to tape. However, nanoFlash accepts and records in either 720p or 1080i formats.

148. Which HD-SDI Switchers are compatible with nanoFlash?

nanoFlash works with most professional HD-SDI switchers with a compatible output format (see recording option and formats section). This makes nanoFlash an ideal live event recorder.

149. Does the nanoFlash require routine maintenance?

Exposure to extreme conditions, such as a sand or dust storm, may require some cleaning. All connectors, regardless of quality and manufacturer, have a finite life. The elimination of routine and expensive maintenance of cameras and tape decks is a distinct advantage of the nanoFlash. Over time, the elimination of these expenses can easily pay for the nanoFlash.

150. Can the nanoFlash be transferred from one camera to another?

Yes, this is one of the best parts. The nanoFlash is easily transported to another camera. The nanoFlash is an investment in the long-term. The image quality is stunning; in our tests, it is visually indistinguishable from uncompressed.

If you upgrade to a new camera, you do not lose your investment in the nanoFlash. There are no mechanical parts to wear out, there is no maintenance, under normal circumstances, and the unit is repairable if the need ever arises.

151. Can nanoFlash be configured offline (PC/Mac)?

Offline configuration is planned for early 2010. Users will be able to select all the various options (bit-rates, audio source, etc) and write a configuration file to a CF card. The card can then be inserted into a nanoFlash and uploaded. Any option can be locked-out from menu changes (ie file format) to prevent accidental changes. Metadata can also be input through this config program.

152. How long does it take to boot up nanoFlash from power-on?

Approximately 5 seconds.

153. How are field updates performed?

New firmware can be downloaded from our website, unzipped, and written to a Compact Flash card. The card can be inserted into nanoFlash and the firmware via a message prompt.

154. Are firmware updates free?

Yes, no charge over the life of the product. Certain major features may be an extra charge item. ASI, GPS Support, and Remote Control via RS-232/RS-245 are planned as extra cost features.

155. Do I need to update my box with all the previous versions of the firmware to get all the latest updates (can I jump from version 1.05 directly to version 1.30, for example)?

nanoFlash FAQs

Firmware version 1.0.64 is a mandatory update. You cannot rollback from version 1.0.64, however, all future versions will support rollback and you can skip from version to version (without updating the intermediate versions).

156. What happens if I lose power during a firmware update?

Firmware version 1.0.64 adds a “golden image” to the internal program memory in the nanoFlash. So, if the power is removed during update, you do not need to send the box back to Convergent Design for repair, just merely rerun the update.

157. Will I be notified of firmware updates?

If you register your unit after purchase (send an e-mail to support@convergent-design.com), then you will automatically receive an e-mail when new firmware is posted to our website.

158. Where is nanoFlash manufactured?

The nanoFlash is manufactured and assembled in Colorado (USA).

159. What’s included in the shipping package?

The nanoFlash, a 110/220V universal power supply, USB CompactFlash card reader, and DVD are included.

160. How long is the warranty?

24-Months limited warranty.

161. Where or how can I buy the nanoFlash?

Check the **Buy or Rent** Tab at: <http://www.convergent-design.com/>

162. How can I reach Sales and Support at Convergent Design?

Sales: ++803-278-0941 (preferred) North Augusta, South Carolina, USA
or ++719-930-1376 North Augusta, South Carolina, USA
Support: ++720-221-3861 Colorado Springs, Colorado, USA
support@convergent-design.com
Main Office: ++720-221-3861 Colorado Springs, Colorado, USA
dan@convergent-design.com or sales@convergent-design.com

163. Do you have a forum for user discussion?

<http://www.dvinfo.net/forum/convergent-design-nanoflash/> and
<http://forums.creativecow.net/convergentdesign>

164. Is the nanoFlash field-ready and field-proven?

Absolutely! nanoFlash has been used in the hot-humid jungles of Papua New Guinea, where tape-based systems have failed. The nanoFlash has flown in a helium balloon up to 90,000 feet with an outside temperature of -70 degrees C. Two nanoFlashes were taken in an underwater 3-D shoot down to 450 feet below sea level. The nanoFlash was even flown in a F22 Raptor with forces exceeding 12gs.

nanoFlash FAQs

165. How does the nanoFlash compare to other portable recorders?

	nanoFlash	Competitor A	Competitor B
Physical			
Size	107 x 94 x 26 mm	155 x 228 x 82 mm	104 x 227 x 83 mm
Package Volume	0.26 cubic meters	2.9 cubic meters	1.9 cubic meters
Weight	0.4 kg	1.67 kg	1.1 kg
Case Construction	All Aluminum	Aluminum + Plastic	Unknown
Mounting	Built into case	Optional Kit	Optional Kit
Power			
DC Voltage Range	6.5 to 19.5 V	12.0 to 18.0 V	7.2 to 7.9 V
Active Power	6 W	30 W	12 W
Standby Mode	0.2 W	Not Available	Yes
I/O Connections			
HD-SDI	Yes	Yes	Yes
HDMI	Yes	Yes	Out Only
1080p30/25/24 Support	Yes	Yes	Playback Only
Analog Video	Not Available	Consumer and Pro	CVBS Out
Analog Audio	Consumer	Consumer and Pro	Consumer Out
LTC	In Only	In and Out	Not Available
Lens Tap	Not Available	Yes	Not Available
Serial Control	RS232/RS485	RS422	Not Available
Firewire/USB	Not Available	Firewire-800	Firewire-400 / USB
Network			
10/100/1000 Ethernet	Not Available	Yes	Not Available
802.11 Wireless	Not Available	Yes	Not Available
Video Processing			
CODEC	MPEG2	Pro Res 422	AVC-I / DVCPProHD
I-Frame Mode	100 to 280 Mbps	140/220 Mbps	50/100 Mbps
Long-GOP	18-180 Mbps	Not Available	Not Available
High-Quality Bit-Rate	100 Mbps: Long-GOP	220Mbps: I-Frame	100Mbps: I-Frame
Raster Sampling	Full	Full	Full / Subsampled
Color	4:2:0/4:2:2	4:2:2	4:2:2/4:2:0
Quantization	8-Bit	8/10-Bit	8/10 Bit

nanoFlash FAQs

	nanoFlash	Competitor A	Competitor B
Up/Down/Cross Conversion	Not Available	Yes	Yes
Media			
Basic Media	Compact Flash (x2)	Hard Drive (x1)	P2 Card (X2)
Media Manufacturers	6	1	2-3
Optional Media	Not Available	Solid-State Drive (x1)	Not Available
	Not Available	SxS Cards (x2)	Not Available
File Formats	QT, MXF, MPG	QT	MXF
QT -> MXF Converter	MAC Only	Not Available	Not Available
Transfer Speed to PC/MAC	4X/8X	1X (Hard Drive)	Unknown
Cost per Hour of Storage	\$230 (Compact Flash)	\$100 (Hard Drive)	\$1000 (P2)
Compatibility			
Final Cut Pro	Excellent	Excellent	Excellent
Avid	Good	Limited	Excellent
Vegas	Excellent	Limited	Unknown
Premiere	Excellent*	Limited	Unknown
Edius	Excellent	Limited	Unknown
Sony XDCAM Optical	Yes	Not Available	Not Available
Features			
Playback on PC	Full-Featured XDCAM Viewer Software		
Playback on MAC			
Deck Control	Limited	Excellent	Excellent
Record Cache	Yes	Not Yet	No
3:2 Pulldown Removal	Yes	Not Yet	Yes
Record Triggers	Multiple	Limited	Limited
Time Lapse	Yes	Not Yet	No
Audio Channels	2	2	8
Two Masters	Yes	Possible, but only on SxS cards	Not Available
Hot Swap	Future	Possible, but only on SxS cards	No
Delete Last Clip			Yes

nanoFlash FAQs

GPS Support	Jan 2010	Unknown	No
	nanoFlash	Competitor A	Competitor B
DVD / Blu-Ray Encoding	Yes	Not Available	Not Available
ASI Option	Yes	Not Available	Not Available
Boot Time	5 Secs	60 Secs	Unknown
LANC	Not Available	Yes	Not Available
MetaData	Future	Yes	Extensive
Operating Range			
Max Altitude	98,000 feet	Unknown	Unknown
Temp Range	-30 to 70 C	Unknown	0 to 40 C
Humidity	5 to 95%	Unknown	10 to 80 %

* Adobe Premiere support requires Main Concept Plugin

*Comparison based on best available information as of 30-Oct-09

166. Any reviews I can read or view?

<http://www.dv.com/article/89554>

http://library.creativecow.net/articles/palmer_michael/nano_and_EX3.php

<http://socialnews.toshiba.co.uk/?ReleaseID=14262>

<http://sportsvideo.org/main/blog/2009/11/20/inertia-unlimited-uses-nanoflash-to-make-tape-decks-smaller-lighter-cheaper/>

http://www.creativevideo.co.uk/public/cvp_videos.php?VID=61&quality=hi

167. Any known issues with the current firmware / hardware?

- Analog audio level meter not quite accurate
- 720p24/25/30 playback not supported (records correctly, however)
- HDMI Output not active in SD mode

ASI Encode/Decode

168. What is ASI?

DVB-ASI is asynchronous serial interface described by EN50083-9. It is used to transport MPEG-2 over coaxial cable, wireless, or fiber optic at 270 Mbps (same rate as SD-SDI). The MPEG-2 (long-GOP) data rate over ASI can be from ~5 to ~15 Mbps for standard definition video and ~18 to ~214 Mbps for high definition video. ASI can also carry MPEG-4 video as well.

nanoFlash FAQs

169. How do I get it on my Flash XDR/nanoFlash?

The ASI feature is a \$995 option added to your Flash XDR/nanoFlash either at the time of purchase or easily enabled via a firmware update in the field using a compact flash card. The option is activated via a file loaded into the Flash XDR/nanoFlash tied to the serial number of your unit.

170. Why use ASI over coax cable when coax can carry uncompressed HD-SDI?

At 270 Mbps, quality coax cable can be run >400 meters with modern, quality SDI/ASI transmitters/receivers, while at 1485 Mbps (HD-SDI), coax can only be run ~200 meters. Also, a single coax running ASI can carry eleven, 19 Mbps video streams. ASI maximum data rate is an aggregate ~214 Mbps over one cable.

171. How do you do wireless HD?

MPEG-2 long-GOP is a very efficient CODEC due to the time based compression algorithms used. This means that the CODEC only saves the video data that has changed over time. I-Frame based CODECs such as JPEG, DV, etc. compress each frame individually, storing extra data that is not necessarily needed. MPEG-2 long-GOP is about 2-3 time more efficient than I-frame based CODECs. This means low bit-rate high definition MPEG-2 long-GOP still looks very good. To do wireless over a reasonable distance, low bit-rate is the key. Wireless modulators/demodulators from companies like Broadcast Microwave Services (BMS) have been tested and verified to work with the Flash XDR/nanoFlash.

172. What about decoding the ASI stream?

The Flash XDR/nanoFlash works as both an ASI encoder and decoder. The ASI decoder is only designed to work with a Flash XDR/nanoFlash encoder.

173. Why not make a universal ASI decoder?

Affordable universal ASI decoders currently exist.

174. Does the Flash XDR/nanoFlash operate in byte or burst mode?

The Flash XDR/nanoFlash currently operates in burst mode.

175. Does the Flash XDR/nanoFlash operate in 188 or 204 byte packets?

188 byte packets are ASI packets without any error correction, while the 204 byte packets incorporate error correction and are used mainly in wireless application. The Flash XDR/nanoFlash encodes with 188 byte packets. The ASI decode function supports both as wireless modulators/demodulators output a 204 byte packet.

176. How do I get the video/audio into the Flash XDR/nanoFlash?

nanoFlash FAQs

The Flash XDR and nanoFlash both accept HD/SD-SDI video with embedded audio. The nanoFlash also accepts HDMI video with embedded audio. The Flash XDR has 2 channel balanced analog audio inputs with phantom power and microphone support. The nanoFlash has 2 channel unbalanced analog audio input to go with the 2 channel embedded audio support.

177. What bit-rates does the Flash XDR/nanoFlash support?

- 5, 6, 7, 8, and 9 Mbit for standard definition (4:2:0)
- 19, 25, 35 Mbit for high definition (4:2:0)
- 50 Mbit for high definition (4:2:2). Note that your decoder will need to be able to support 4:2:2 decoding. The Flash XDR/nanoFlash is able to decode 4:2:2.

178. Why doesn't the Flash XDR/nanoFlash support X/custom bit-rate?

To make the Flash XDR/nanoFlash simple to use, we pre-defined bit-rates that are common in the industry. If you need a specific bit-rate, drop us an email and we will consider adding it..

179. What about 4:2:2 ASI encoding?

The Flash XDR/nanoFlash can encode video at 50 Mbit 4:2:2. This offers supreme quality at the cost of bandwidth.

180. Can the Flash XDR/nanoFlash support both 16X9 and 4X3 standard definition?

Yes, there is an option in the video menu to specify whether the SD video is compressed as 4X3 or 16X9.

181. What video formats are supported?

- 1080i60/59.94/50
- 1080p30/29.97/25/24/23.96
- 720p60/59.94/50
- 576i, 486i (PAL, NTSC)

182. How is the audio handled?

The 2 channel audio, either from embedded or analog source, is compressed using MPEG1 layer 2 at 384 Kbps.

183. What is the latency through the encode/decode process?

- Encoding takes approximately 4 frames or ~120 mSec.
- Decode takes approximately 4 frames or ~120 mSec

nanoFlash FAQs

184. What are the PIDs of the PCR, PMT, program number, video, and audio? Are they programmable?

- Video PID: 0x0810 (decimal 2064)
- Audio PID: 0x0814 (2068)
- PCR PID: 0x0134 (308)
- PMT PID: 0x0081 (129)
- Program number: 0x01 (1)
- In the near future, a firmware update will be released that will make these values programmable.

185. How have you verified compatibility with ASI decoders and adherence to the ASI specification?

- Tektronix MTS 400 MPEG/ASI analyzer no errors
- Miranda IRD-3802 ASI decoder fully functional
- Miranda HD-Bridge DEC+ ASI decoder fully functional
- Tandberg RX1290 ASI decoder fully functional
- Sencore IRD3187A ASI decoder fully functional
- Flash XDR/nanoFlash ASI decoder fully functional

186. Can this be used to generate digital television (DTV) over coax?

Yes, when paired up with a QAM modulator, you can create a DTV signal that any DTV television can decode and display. This coax can be run long distance and multiple channels can be ganged together. An example is the Blonder Tongue AQM QAM modulator.

187. Can I use multiple units to create multiple channels on a DTV cable network (for a school, hotel, etc.)?

Yes, multiple units can be paired with QAM modulators to create a multi channel DTV network.

188. Can the ASI output of a Flash XDR/nanoFlash be broadcast over a LAN/WAN?

Yes, you can use an ASI to USB adapter (like the Alitronika AT4USB), TSReader software, and VLC to broadcast over a LAN/WAN. You can then view the video/audio on a client computer using VLC. Another option is to use an ASI to Ethernet converter.

189. Can the Flash XDR/nanoFlash record to Compact flash while it is encoding to ASI?

Not at this time.

nanoFlash FAQs

190. Can the Flash XDR/nanoFlash record ASI to a card and then play off the card to an ASI stream at a later time?

Not at this time.

191. Can the Flash XDR/nanoFlash still be used as a recorder once ASI is activated?

Yes, there is a menu option to put the unit in ASI mode. Take the unit out of ASI mode and it acts like a solid state recorder.

192. How much power does the Flash XDR/nanoFlash use?

- The Flash XDR uses 12-14 watts (depending on if analog audio is activated).
- The nanoFlash uses 6 watts.

193. Can the Flash XDR/nanoFlash be configured to power up automatically and start encoding/decoding?

Yes, this was done to support remote units so if the power was removed, when it came back, the unit would power up and start encoding/decoding as soon as it sees a valid video/ASI signal.

194. Does the Flash XDR/nanoFlash store settings through a power cycle?

Yes, all settings are stored.

195. How do I start the Flash XDR/nanoFlash encoding or decoding?

The Flash XDR/nanoFlash automatically starts encoding when it sees a valid video signal and decoding when it sees a valid ASI signal.

196. How do I know the quality of the video is any good?

We use the Sony 6th generation MPEG-2 CODEC. This is the same CODEC used in the PDW-800 professional XDCAM-HD camera.

197. How can I get more information?

Please send any questions to sales (at) convergent-design.com or call (720) 221-3861 (US Mountain Time)